

Company Interiors
35035 Sterling, Matrix Alpha

35035 STERLING, MATRIX ALPHA FLOOR PLAN

- A1** EXTERNAL GLAZING MANIFESTATION
- A2** INTERNAL GLAZING MANIFESTATION
- B** 2no. ELEVATIONS OF STOREWALL GRAPHICS
- C** ALTO BOX BAFFLES (3no. SETS OF 8 BAFFLES PER AREA)
- D** 9no. ALTO SUSPENDED ACOUSTIC SCREENS
- E** 10no. 1200mm ACOUSTIC CIRCULAR CEILING RAFTS
7no. 800mm ACOUSTIC CIRCULAR CEILING RAFTS
- F** FEATURE ACOUSTIC FABRIC WALLS
CONFERENCE ROOM & PRINT AREA
- G** ALTO FLOOR TO CEILING BOX FINS

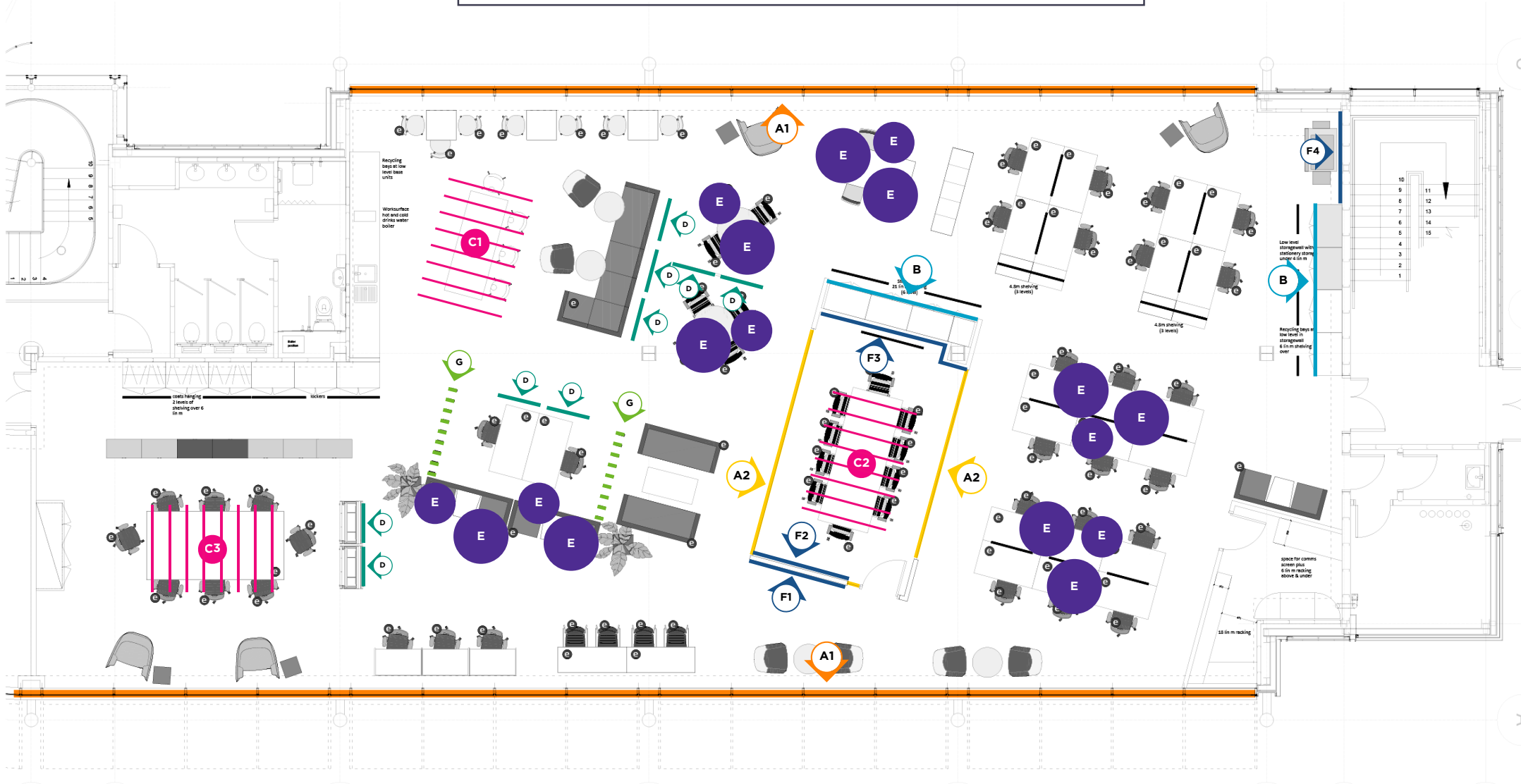

Item A1 - EXTERNAL Glazing manifest

OPTION 1



EXAMPLE ELEVATION

Light etch Vinyl CAD cut

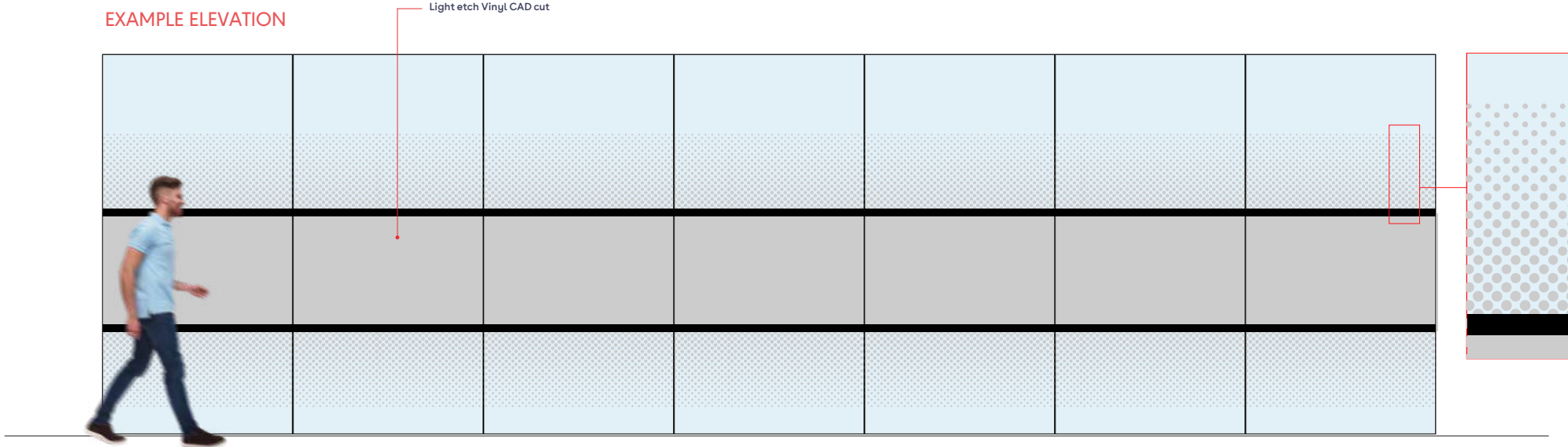

Company Interiors • 35035 Sterling, Matrix Alpha, Swansea



Item A - Manifestation (EXTERNAL)
CAD cut manifest in light etch

Artworks Solutions Ltd
Unit 4 Sheene Road, Bristol BS3 4EG / 42-46 Princelet Street, London E1 5LP
t.0117 9666 331 e.sales@artworks-solutions.com w.artworks-solutions.com

Disclaimer. We advise that you review your job carefully before approving. We encourage you to carefully check the content and pay special attention to the following items: spelling, fonts, grammar, punctuation, graphics, colour and finished size. After a proof is approved by yourself, Artworks are not liable for errors and a charge may be applicable to reproduce the artwork.



Item A1 - EXTERNAL Glazing manifest

OPTION 2



EXAMPLE ELEVATION

Light etch Vinyl CAD cut

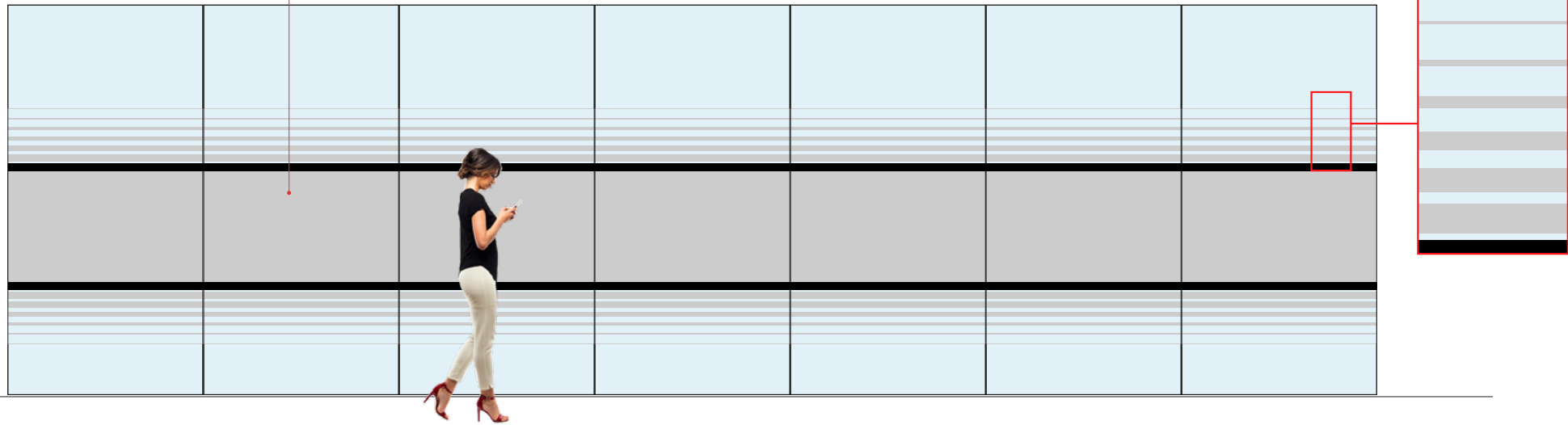

Company Interiors • 35035 Sterling, Matrix Alpha, Swansea



Item A - Manifestation (EXTERNAL)
CAD cut manifest in light etch

Item A1 - EXTERNAL Glazing manifest

OPTION 3



EXAMPLE ELEVATION

Light etch Vinyl CAD cut

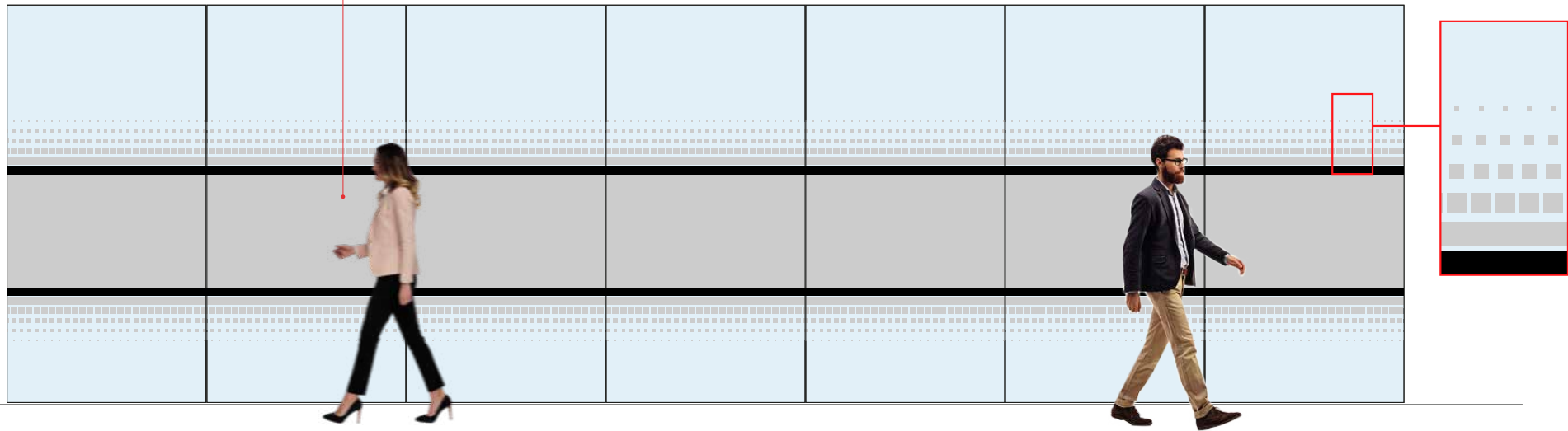

Company Interiors • 35035 Sterling, Matrix Alpha, Swansea



Item A - Manifestation (EXTERNAL)
CAD cut manifest in light etch

Artworks Solutions Ltd
Unit 4 Sheene Road, Bristol BS3 4EG / 42-46 Princelet Street, London E1 5LP
t.0117 9666 331 e.sales@artworks-solutions.com w.artworks-solutions.com

Disclaimer. We advise that you review your job carefully before approving. We encourage you to carefully check the content and pay special attention to the following items: spelling, fonts, grammar, punctuation, graphics, colour and finished size. After a proof is approved by yourself, Artworks are not liable for errors and a charge may be applicable to reproduce the artwork.



Item A2 - INTERNAL Glazing manifest

OPTION 1

INSPIRATION FORM WEBSITE



INTERNAL OFFICE - SIDE 1



INTERNAL OFFICE - SIDE 2

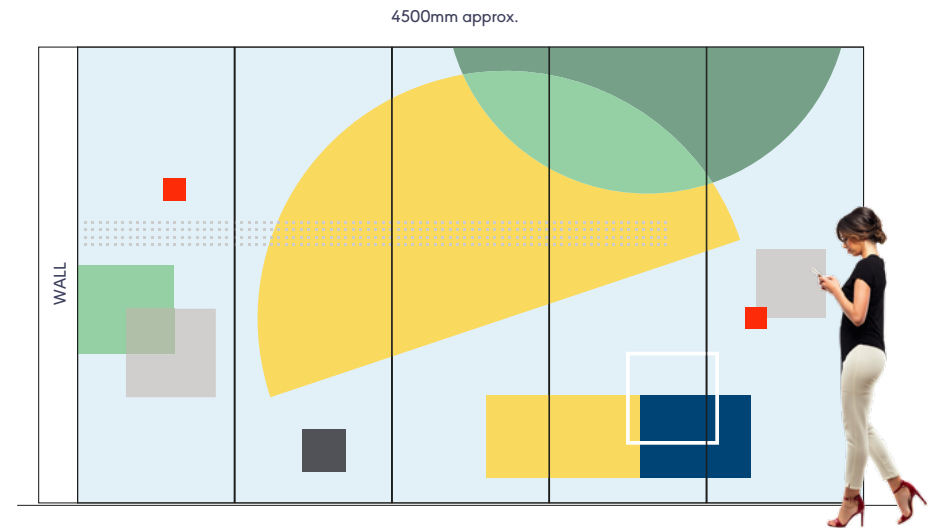

Company Interiors • 35035 Sterling, Matrix Alpha, Swansea



Item A - Manifestation (INTERNAL)
Printed optically clear

Artworks Solutions Ltd
Unit 4 Sheene Road, Bristol BS3 4EG / 42-46 Princelet Street, London E1 5LP
t.0117 9666 331 e.sales@artworks-solutions.com w.artworks-solutions.com

Disclaimer. We advise that you review your job carefully before approving. We encourage you to carefully check the content and pay special attention to the following items: spelling, fonts, grammar, punctuation, graphics, colour and finished size. After a proof is approved by yourself, Artworks are not liable for errors and a charge may be applicable to reproduce the artwork.



Item A2 - INTERNAL Glazing manifest

OPTION 2



INTERNAL OFFICE - SIDE 1

5500mm approx.

printed optically clear vinyl
reverse applied to glazing

White Ink
printed



INTERNAL OFFICE - SIDE 2

4500mm approx.

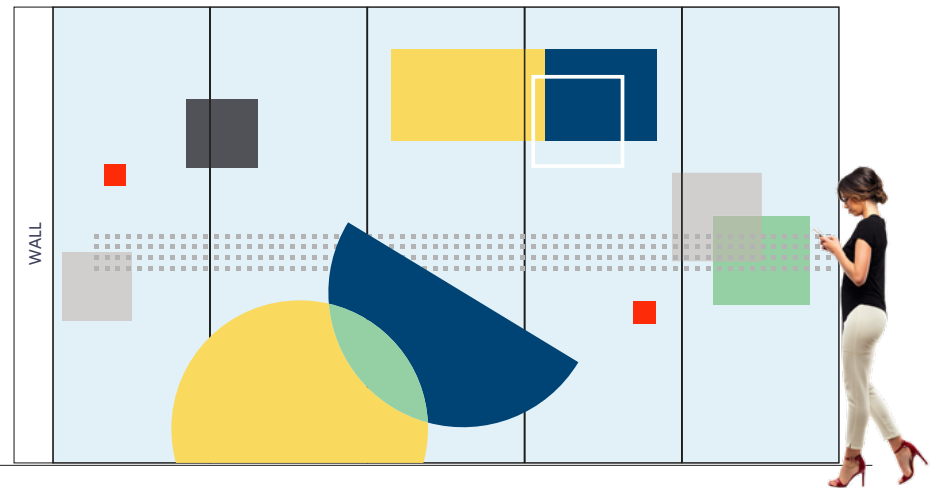

Company Interiors • 35035 Sterling, Matrix Alpha, Swansea



Item A - Manifestation (INTERNAL)
Printed optically clear

Item B - STORE WALL GRAPHICS

OPTION 1

FULL HEIGHT STORE WALL GRAPHICS

printed Hi tac vinyl with textured over lamiate



2600mm approx.

HALF HEIGHT STORE WALL GRAPHICS

printed Hi tac vinyl with textured over lamiate



Company Interiors • 35035 Sterling, Matrix Alpha, Swansea



Item B - Feature graphics to storewall
split across panels. Full colour UV cured feature graphics to hi tac vinyl with textured laminate

Item B - STORE WALL GRAPHICS

OPTION 2

FULL HEIGHT STORE WALL GRAPHICS

printed Hi tac vinyl with textured over lamiante

HALF HEIGHT STORE WALL GRAPHICS

printed Hi tac vinyl with textured over lamiante

2600mm approx.

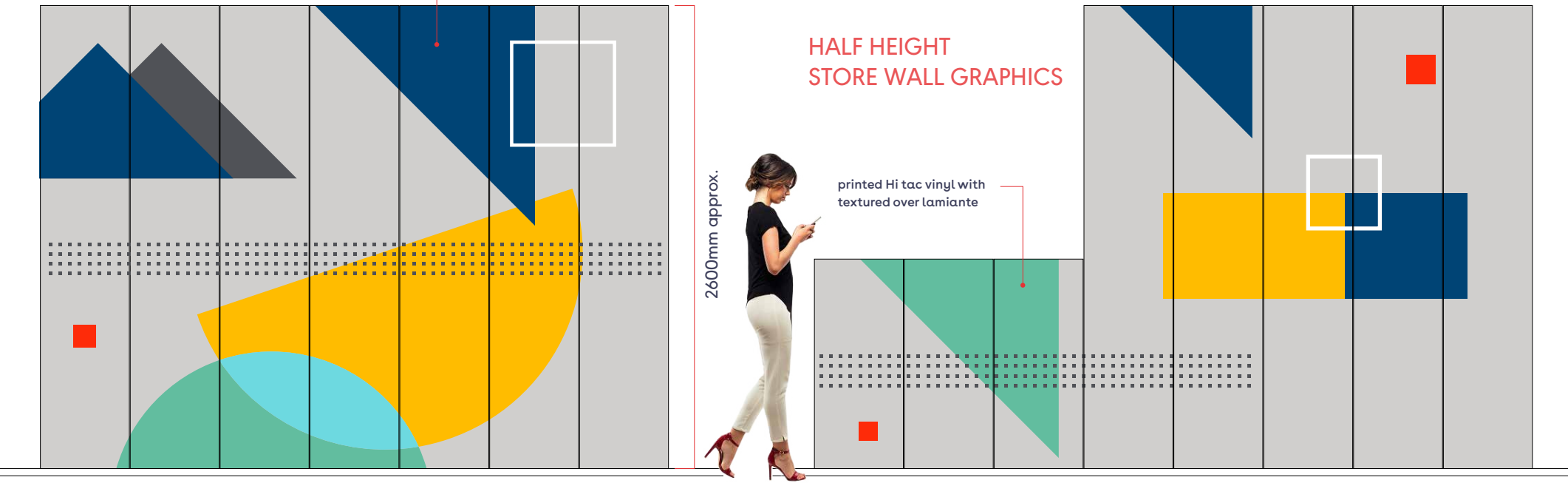

Company Interiors • 35035 Sterling, Matrix Alpha, Swansea



Item B - Feature graphics to storewall split across panels. Full colour UV cured feature graphics to hi tac vinyl with textured laminate



Item C -
CEILING BOX BAFFLES

24no. baffles (3 sets of 8no.)

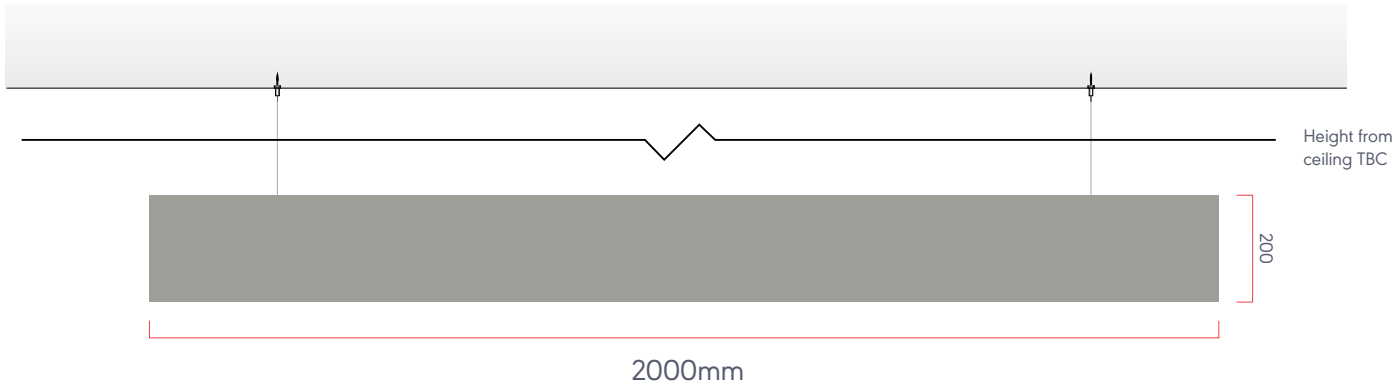

COLOUR TBC



12mm FOLDED ALTO BOX BAFFLES COLOUR TBC
HUNG ON ADJUSTABLE WIRES
WITH HIDDEN U CHANNEL FIXING
SCREWED TO INSIDE OF BULKHEAD

SIDE PROFILE

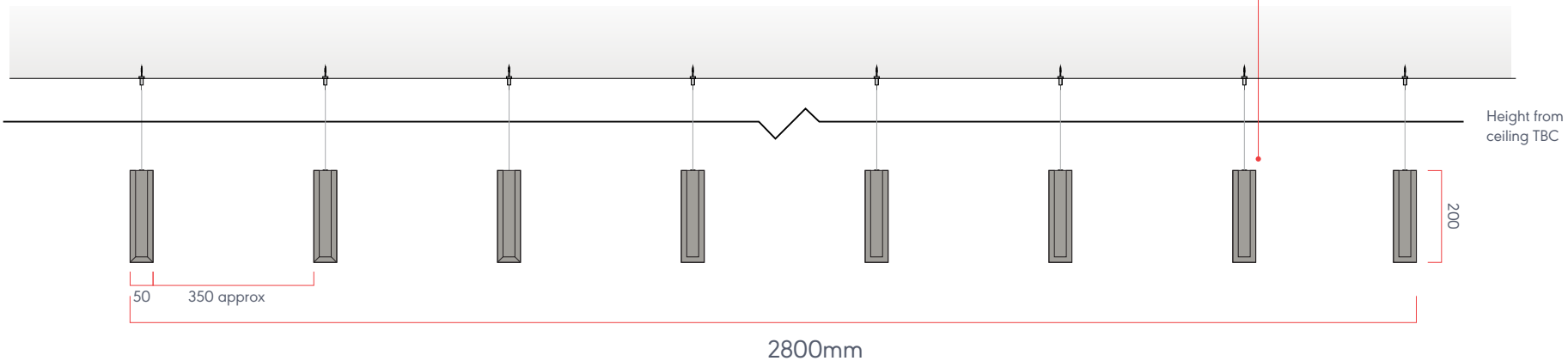

Company Interiors • 35035 Sterling, Matrix Alpha, Swansea



Item C - Ceiling acoustic box baffles

24no. 2000 x 200mm deep x 50mm thick fabricated box baffle in 12mm ALTO acoustic. Baffles mounted to U channel sprayed black and screwed inside bulk head

Item D -
SUSPENDED ACOUSTIC SCREENS
 OPTION 1

Qty 9

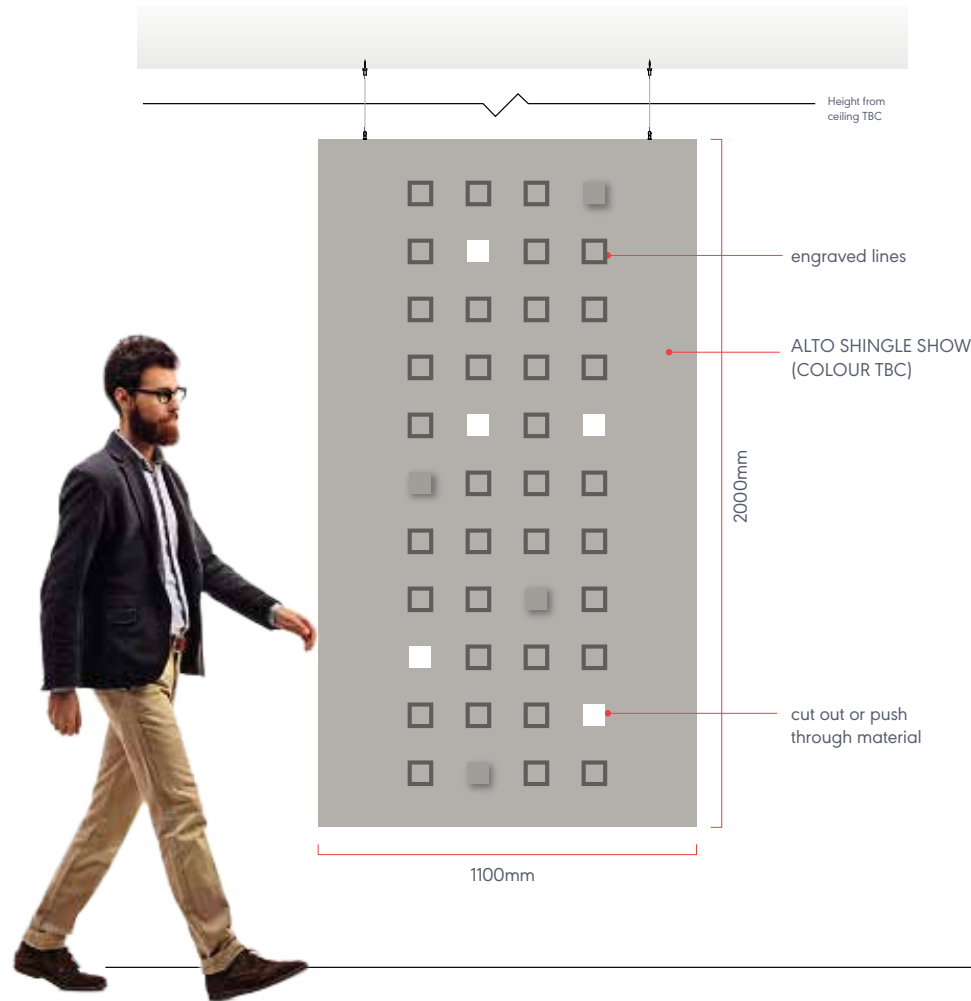

COLOUR TBC

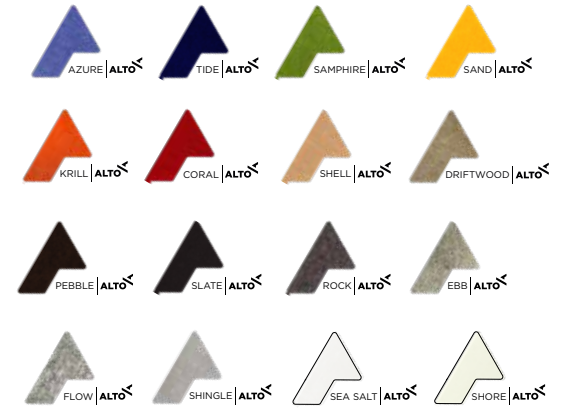

Company Interiors • 35035 Sterling, Matrix Alpha, Swansea



Item D - Alto suspended acoustic screens
 9no. 1.1 x 2m, 12mm ALTO recycled polyester screens with engraved/cut out geometric design.
 Suspended on 2no. adjustable wire fixings

Item D -
SUSPENDED ACOUSTIC SCREENS
 OPTION 2

Qty 9

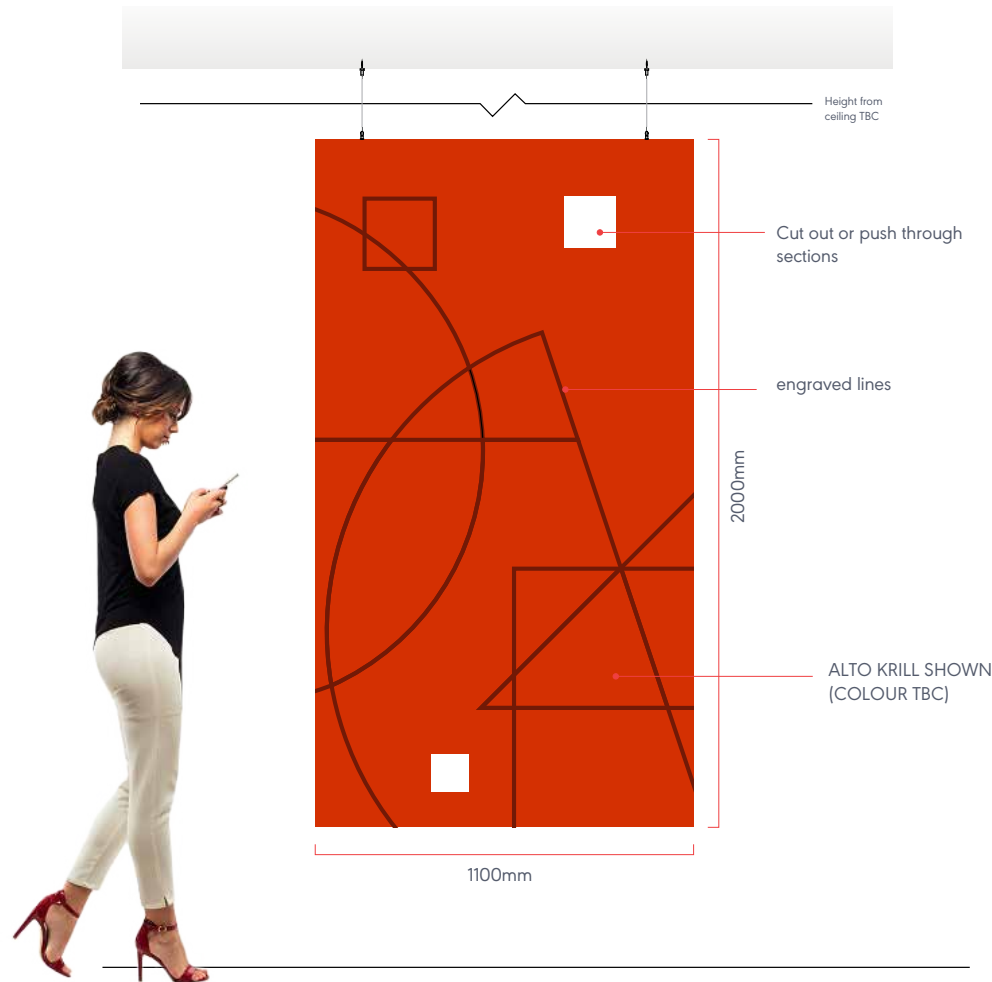

COLOUR TBC

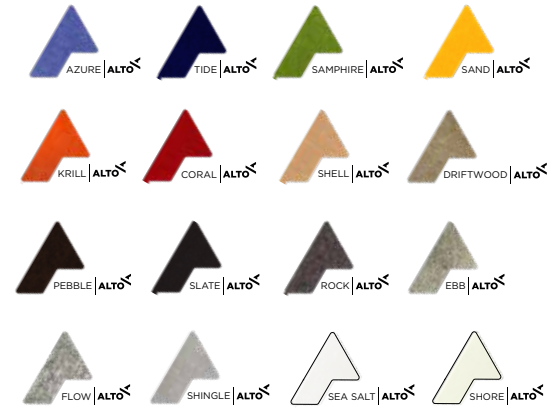

Company Interiors • 35035 Sterling, Matrix Alpha, Swansea



Item D - Alto suspended acoustic screens
 9no. 1.1 x 2m, 12mm ALTO recycled polyester screens with engraved/cut out geometric design.
 Suspended on 2no. adjustable wire fixings

Item E -
CIRCULAR CEILING PANELS
 OPTION 1

Qty 10

1200mm

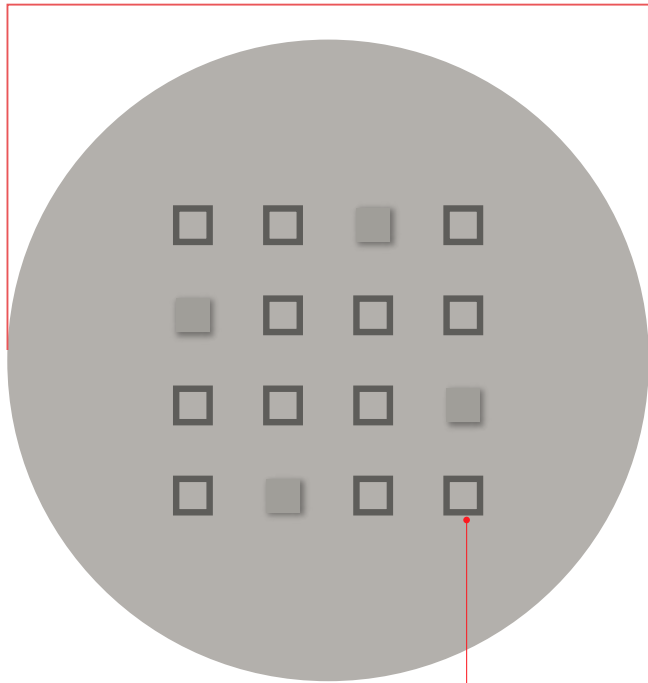

Qty 7

800mm

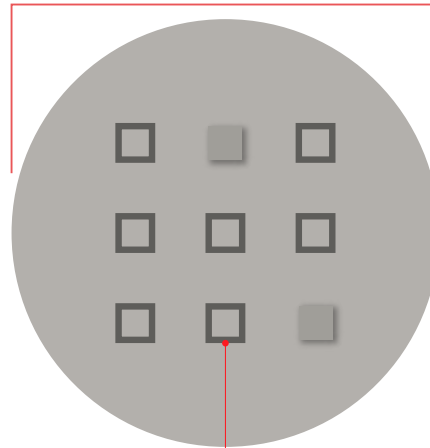

24mm ALTO (SHINGLE SHOWN)
 COLOUR TBC
 with optional engraved / push through design

HANGING PROFILE DETAIL

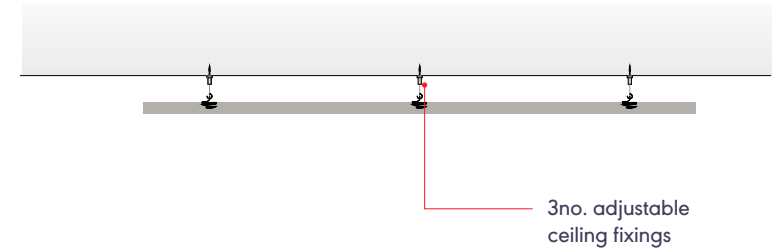
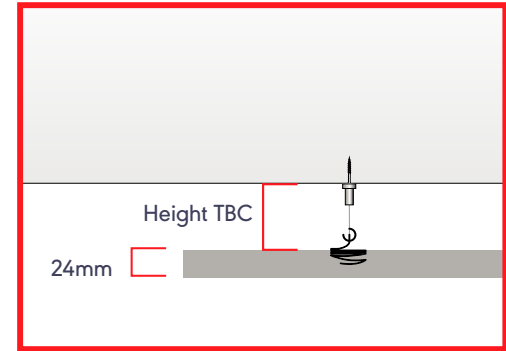

COLOUR TBC

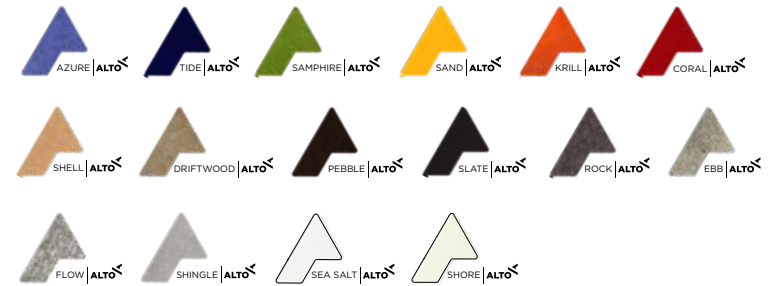

Company Interiors • 35035 Sterling, Matrix Alpha, Swansea



Item E - Acoustic circular Ceiling Rafts
 10no. 1200mm dia 24mm (Colour TBC). with engraved custom design. Suspended on 3no. adjustable ceiling wire.
 7no. 800mm dia 24mm (Colour TBC). with engraved custom design. Suspended on 3no. adjustable ceiling wire.

Item E -
CIRCULAR CEILING PANELS
OPTION 2

Qty 10

1200mm

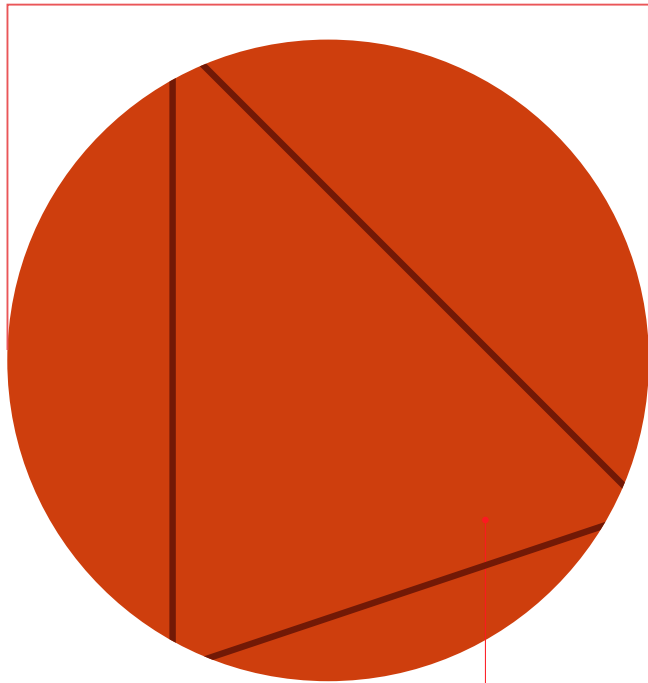

Qty 7

800mm

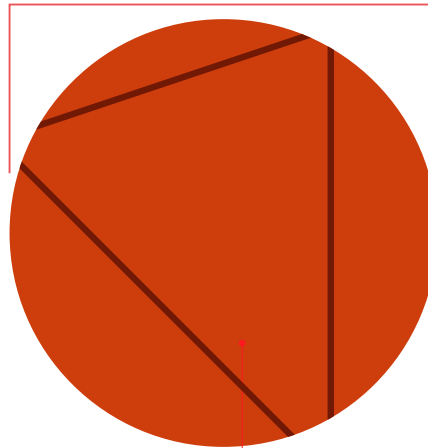

24mm ALTO (KRILL SHOWN)
 COLOUR TBC
 with optional engraved / push through design

HANGING PROFILE DETAIL

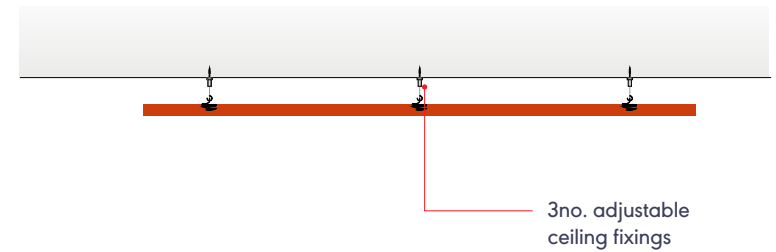
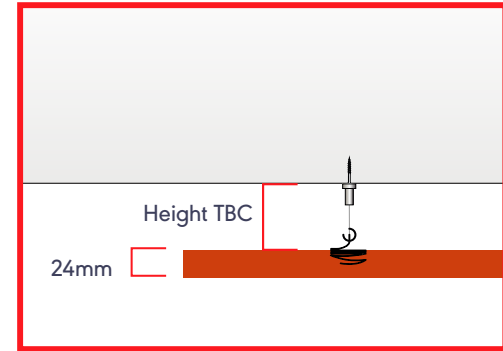

COLOUR TBC

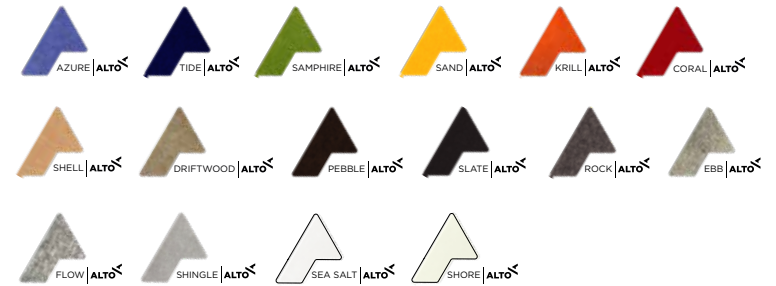

Company Interiors • 35035 Sterling, Matrix Alpha, Swansea



Item E - Acoustic circular Ceiling Rafts
 10no. 1200mm dia 24mm (Colour TBC). with engraved custom design. Suspended on 3no. adjustable ceiling wire.
 7no. 800mm dia 24mm (Colour TBC). with engraved custom design. Suspended on 3no. adjustable ceiling wire.

Item F -
FEATURE ACOUSTIC
FABRIC WALLING

F1. CONFERENCE ROOM - EXTERNAL ELEVATION

OTHER COLOUR OPTIONS

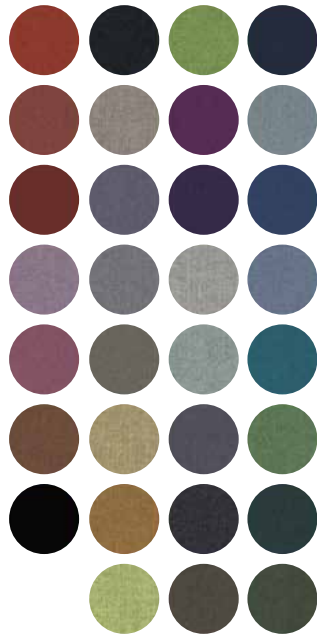

Company Interiors • 35035 Sterling, Matrix Alpha, Swansea



Item F - Feature acoustic fabric walling
11.5 l'ms x 2.6m h O/A. Runs tracked out with 25mm Novawall with inlaid 25mm sound absorber with Camira 'Blazerlite' to the face.

Item F -
FEATURE ACOUSTIC
FABRIC WALLING

F2. CONFERENCE ROOM - INTERNAL ELEVATION

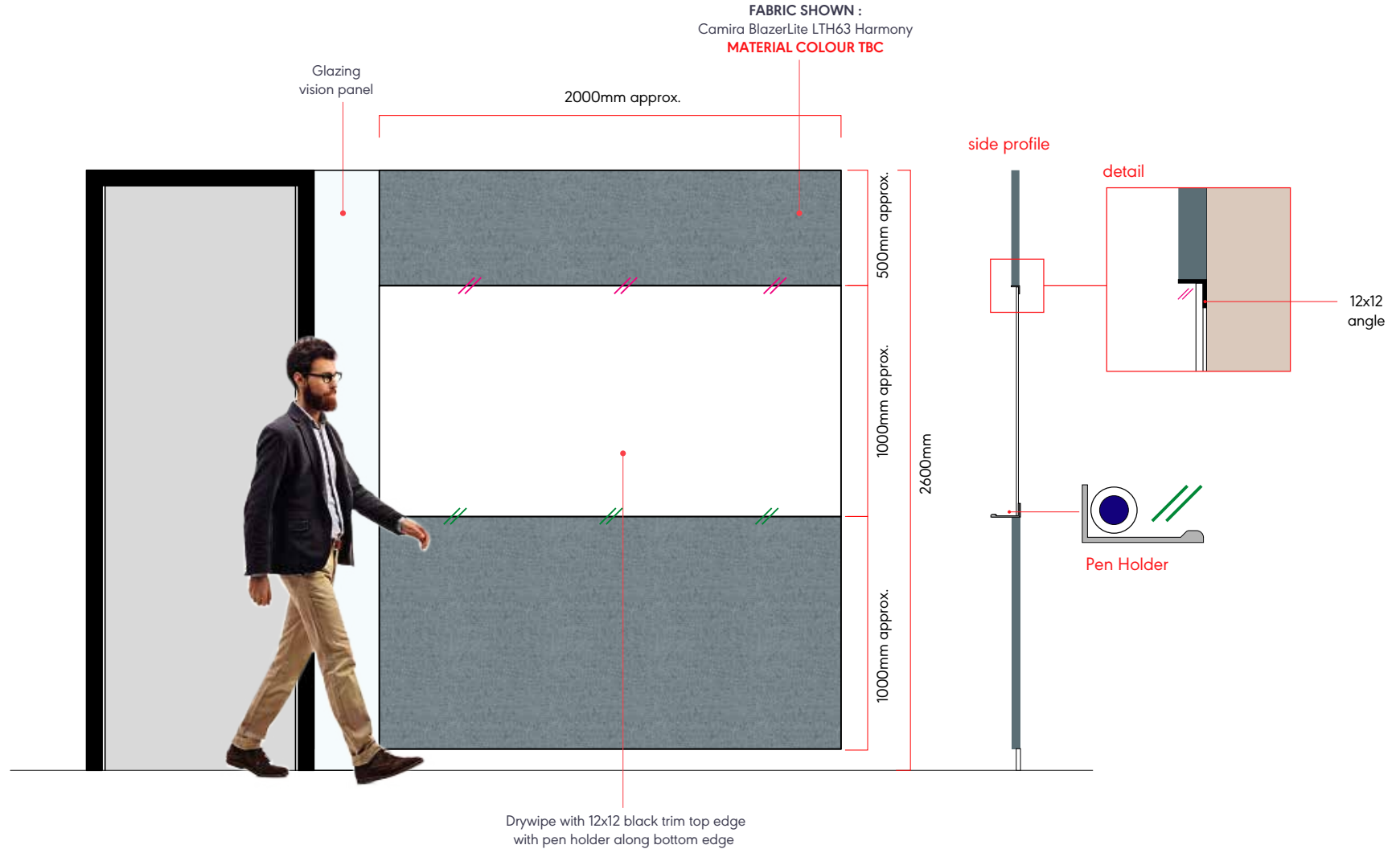

Company Interiors • 35035 Sterling, Matrix Alpha, Swansea



Item F - Feature acoustic fabric walling
11.5 l'rms x 2.6m h O/A. Runs tracked out with 25mm Novawall with inlaid 25mm sound absorber with Camira 'Blazerlite' to the face.

Item F -
FEATURE ACOUSTIC
FABRIC WALLING

F3. CONFERENCE ROOM - INTERNAL ELEVATION

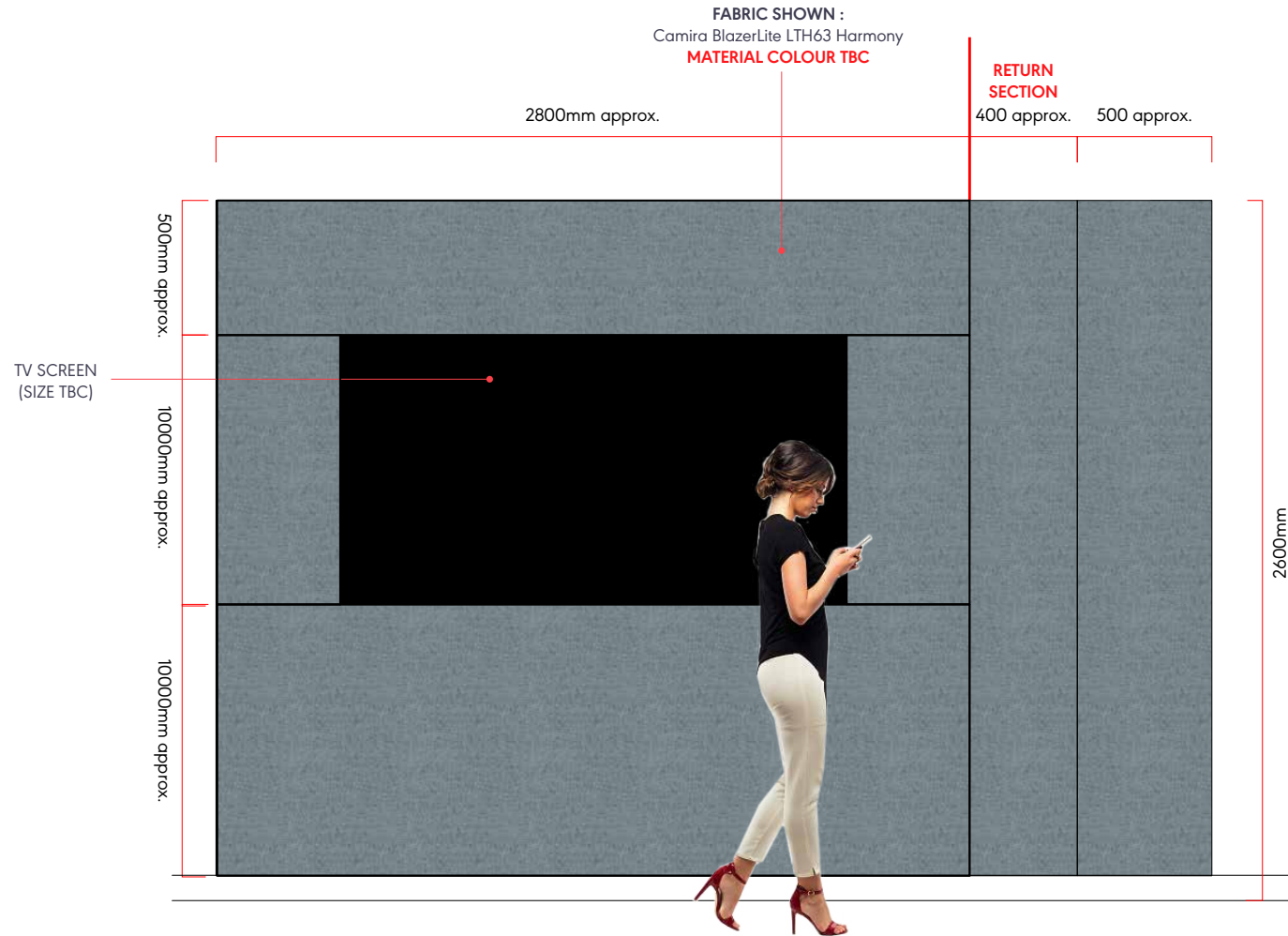

Company Interiors • 35035 Sterling, Matrix Alpha, Swansea

Item F - Feature acoustic fabric walling

11.5 l'ms x 2.6m h O/A. Runs tracked out with 25mm Novawall with inlaid 25mm sound absorber with Camira 'Blazerlite' to the face.

Artworks Solutions Ltd

Unit 4 Sheene Road, Bristol BS3 4EG / 42-46 Princelet Street, London E1 5LP
t.0117 9666 331 e.sales@artworks-solutions.com w.artworks-solutions.com

Disclaimer. We advise that you review your job carefully before approving. We encourage you to carefully check the content and pay special attention to the following items: spelling, fonts, grammar, punctuation, graphics, colour and finished size. After a proof is approved by yourself, Artworks are not liable for errors and a charge may be applicable to reproduce the artwork.

MF

Item F -
FEATURE ACOUSTIC
FABRIC WALLING

F4. PRINT AREA

FABRIC SHOWN :
Camira BlazerLite LTH63 Harmony
MATERIAL COLOUR TBC

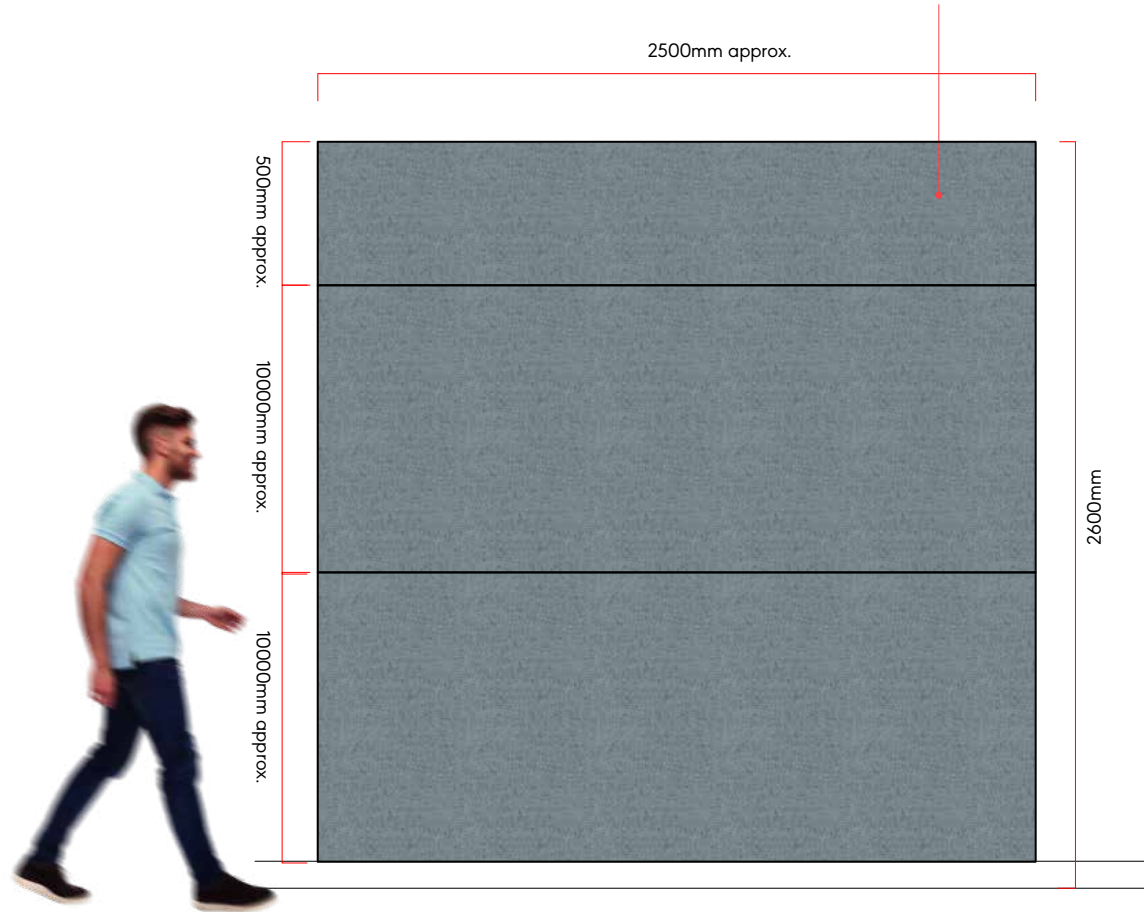

Company Interiors • 35035 Sterling, Matrix Alpha, Swansea



Item F - Feature acoustic fabric walling

11.5 l'rs x 2.6m h O/A. Runs tracked out with 25mm Novawall with inlaid 25mm sound absorber with Camira 'Blazerlite' to the face.

Artworks Solutions Ltd

Unit 4 Sheene Road, Bristol BS3 4EG / 42-46 Princelet Street, London E1 5LP
t.0117 9666 331 e.sales@artworks-solutions.com w.artworks-solutions.com

Disclaimer. We advise that you review your job carefully before approving. We encourage you to carefully check the content and pay special attention to the following items: spelling, fonts, grammar, punctuation, graphics, colour and finished size. After a proof is approved by yourself, Artworks are not liable for errors and a charge may be applicable to reproduce the artwork.

MF

Item G -
ACOUSTIC BOX FINS

18no. baffles (2 sets of 9no.)

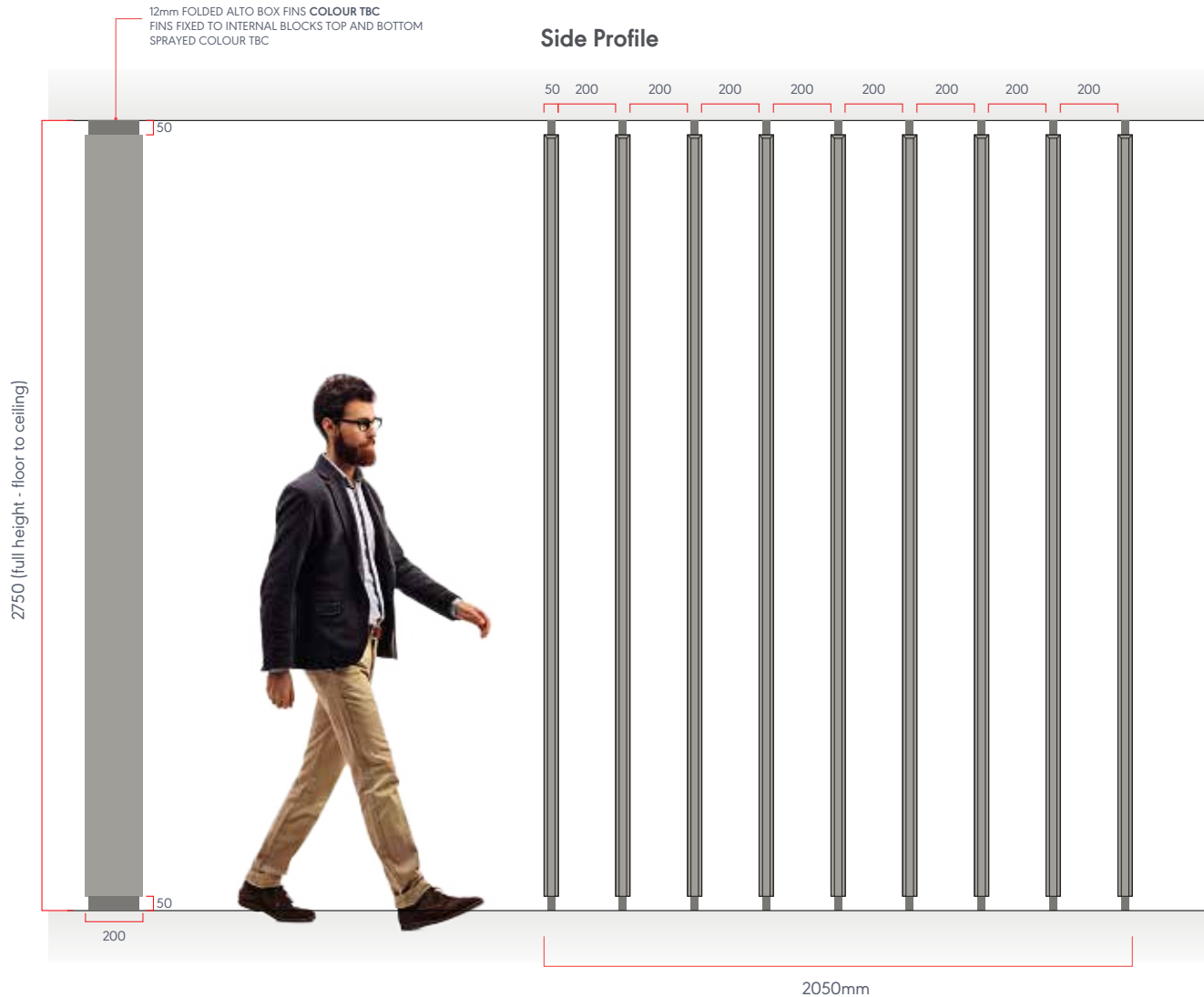

COLOUR TBC

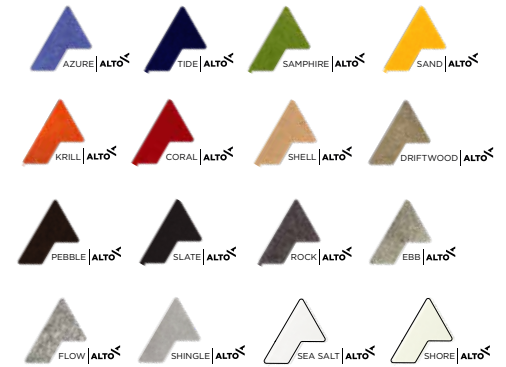

Company Interiors • 35035 Sterling, Matrix Alpha, Swansea



Item G - ALTO Floor to Ceiling acoustic box FINS

18no. 200 x 50mm thick x 2750 full height) 12mm alto folded box fins Fins fixed to internal blocks top and bottom - sprayed colour TBC

Artworks Solutions Ltd

Unit 4 Sheene Road, Bristol BS3 4EG / 42-46 Princelet Street, London E1 5LP
t.0117 9666 331 e.sales@artworks-solutions.com w.artworks-solutions.com

Disclaimer. We advise that you review your job carefully before approving. We encourage you to carefully check the content and pay special attention to the following items: spelling, fonts, grammar, punctuation, graphics, colour and finished size. After a proof is approved by yourself, Artworks are not liable for errors and a charge may be applicable to reproduce the artwork.



Artworks Solutions Ltd

Unit 4 Sheene Road, Bristol BS3 4EG / 42-46 Princelet Street, London E1 5LP
t.0117 9666 331 e.sales@artworks-solutions.com w.artworks-solutions.com

